

MKIII MONO MOUNT

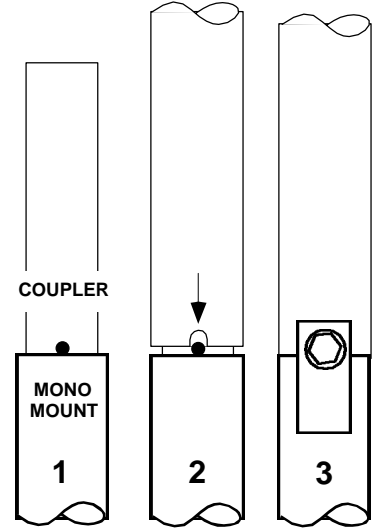

INSTRUCTIONS FOR SECURING THE MKIII TO THE MONO MOUNT

1. Place the coupler into the mount tube. Rotate the coupler until the hole is facing you.
2. Lower the MKIII onto the coupler, aligning the slot with the hole.
3. Fasten the clamp loosely in place with the screw provided. Rotate the station until the solar panel is facing TRUE SOUTH. Tighten the clamp screw to prevent rotation of the MKIII.

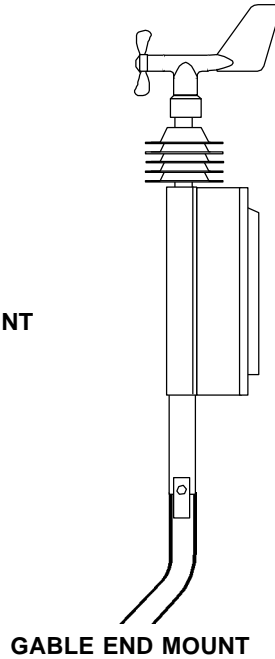
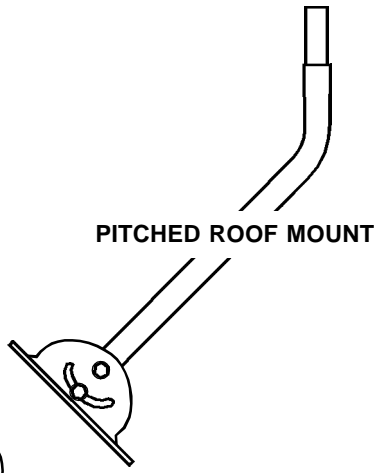
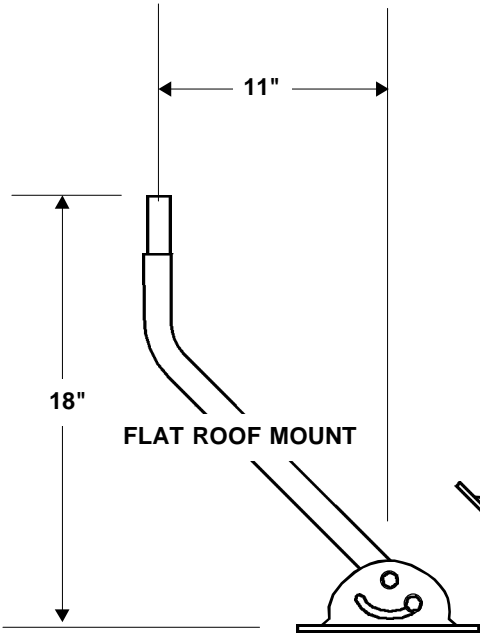
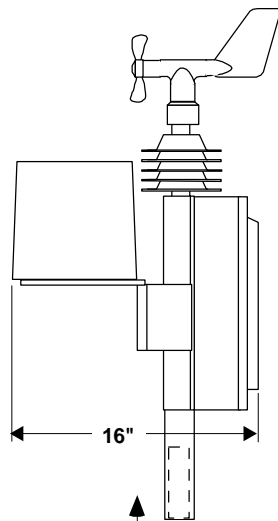
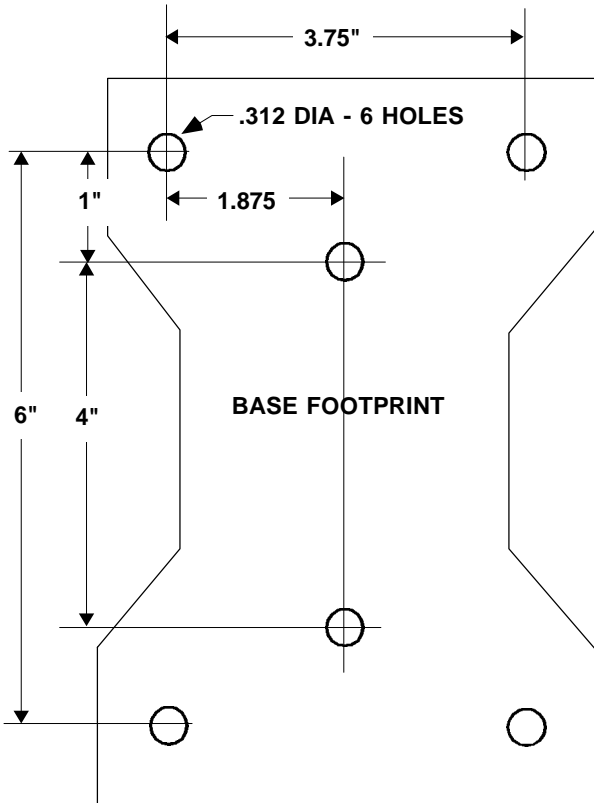

EXTENSION TUBE-
(CAUTION: DO NOT USE WITH MONO MOUNT)

MKIII WITH INTEGRAL RAIN GAUGE

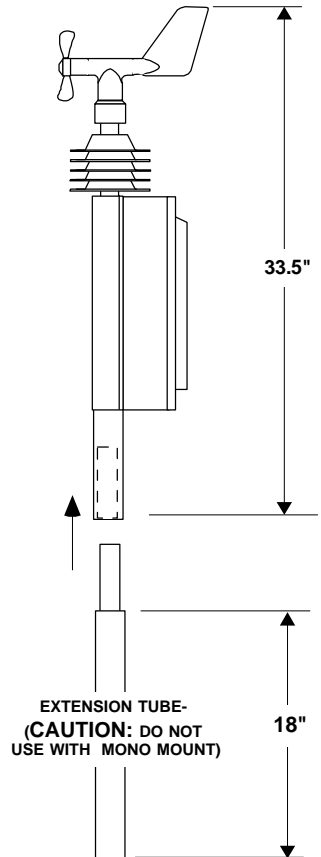

EXTENSION TUBE-
(CAUTION: DO NOT USE WITH MONO MOUNT)

MKIII



RainWise Inc.

P.O. Box 443 • BAR HARBOR, MAINE 04609-0443 • 800-762-5723
VISIT OUR WEBSITE AT www.rainwise.com